

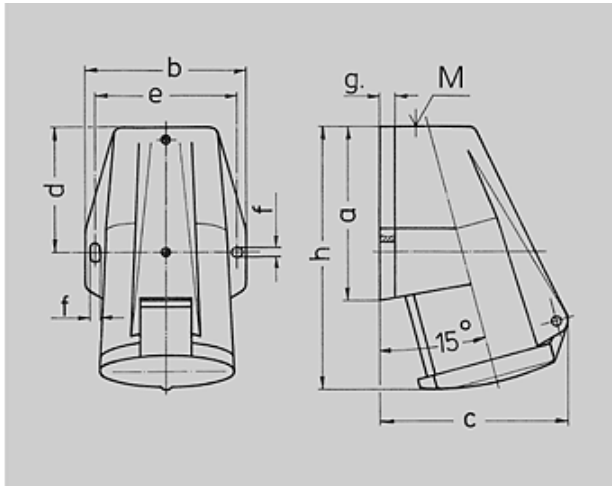

Part no. : 1369

Receptacle

external fixing, one cable entry from top



| Drawing | Amp. | 16 | | | 32 | | |
|------------|---|----------------|-----|------|------|------|-----|
| | | 1 MB 205 Poles | | | 3 | 4 | 5 |
| Dim. in mm | a | 91 | 91 | 91 | 102 | 102 | 102 |
| | b | 73 | 79 | 87 | 89 | 89 | 94 |
| | c | 86 | 93 | 99 | 108 | 108 | 114 |
| | d | 55 | 55 | 56,4 | 62 | 62 | 62 |
| | e | 62 | 68 | 76 | 77,5 | 77,5 | 84 |
| | f | 5,3 | 5,3 | 5,3 | 5,3 | 5,3 | 5,3 |
| | g. | 8 | 8 | 9 | 10 | 10 | 10 |
| | h | 132 | 132 | 132 | 153 | 153 | 153 |
| | M | 20 | 25 | 25 | 25 | 25 | 32 |
| | Max. cabel diam. (mm) | 13 | 18 | 18 | 18 | 18 | 25 |
| | Terminal for cond. cross section (mm ²) min.-max. | 1,5 | 1,5 | 1,5 | 2,5 | 2,5 | 2,5 |
| | | -4 | -4 | -4 | -10 | -10 | -10 |

Article-group : 1037

voltages : 230V

rated current : 32A













pole : 3 pole

position of ground contact : 6h

packing unit : 0010

weight : 290 g

PART NUMBERS

| | V | 110V | 230V | 400V | 500V | >50-500V | |
|--------|---|---|---|---|---|---|---|
| | | Hz | 50,60 | 50,60 | 50,60 | 50,60 | 100-300 |
| colour | |  |  |  |  |  |  |
| amp. | |  |  |  |  |  |  |
| 16 A | 3 | 1177 | 1178 | | | | |
| | 4 | | 1267 | 1268 | 1269 | | |
| 32 A | 3 | 1368 | 1369 | | | | |
| | 4 | | 1372 | 1373 | 1374 | | |